

BFP640F

Low Noise Silicon Germanium Bipolar RF Transistor

Data Sheet

Revision 2.0, 2015-03-13

RF & Protection Devices

Edition 2015-03-13

**Published by
Infineon Technologies AG
81726 Munich, Germany**

**© 2015 Infineon Technologies AG
All Rights Reserved.**

Legal Disclaimer

The information given in this document shall in no event be regarded as a guarantee of conditions or characteristics. With respect to any examples or hints given herein, any typical values stated herein and/or any information regarding the application of the device, Infineon Technologies hereby disclaims any and all warranties and liabilities of any kind, including without limitation, warranties of non-infringement of intellectual property rights of any third party.

Information

For further information on technology, delivery terms and conditions and prices, please contact the nearest Infineon Technologies Office (www.infineon.com).

Warnings

Due to technical requirements, components may contain dangerous substances. For information on the types in question, please contact the nearest Infineon Technologies Office.

Infineon Technologies components may be used in life-support devices or systems only with the express written approval of Infineon Technologies, if a failure of such components can reasonably be expected to cause the failure of that life-support device or system or to affect the safety or effectiveness of that device or system. Life support devices or systems are intended to be implanted in the human body or to support and/or maintain and sustain and/or protect human life. If they fail, it is reasonable to assume that the health of the user or other persons may be endangered.

BFP640F, Low Noise Silicon Germanium Bipolar RF Transistor
Revision History: 2015-03-13, Revision 2.0

Page	Subjects (major changes since last revision)
	This data sheet replaces the revision from 2007-05-31. The reason for the new revision is to increase the information content for the circuit designer. The performance parameters are now enlisted in a table containing many relevant application frequencies. The measurements of typical devices have been repeated and the device description has been expanded by adding several new characteristic curves. For customers who bought the product prior to the issue of the new revision the old specifications remain valid.

Trademarks of Infineon Technologies AG

AURIX™, C166™, CanPAK™, CIPOS™, CIPURSE™, EconoPACK™, CoolMOS™, CoolSET™, CORECONTROL™, CROSSAVE™, DAVE™, DI-POL™, EasyPIM™, EconoBRIDGE™, EconoDUAL™, EconoPIM™, EconoPACK™, EiceDRIVER™, eupec™, FCOS™, HITFET™, HybridPACK™, I²RF™, ISOFACE™, IsoPACK™, MIPAQ™, ModSTACK™, my-d™, NovalithIC™, OptiMOS™, ORIGA™, POWERCODE™, PRIMARION™, PrimePACK™, PrimeSTACK™, PRO-SIL™, PROFET™, RASIC™, ReverSave™, SatRIC™, SIEGET™, SINDRION™, SIPMOS™, SmartLEWIS™, SOLID FLASH™, TEMPFET™, thinQ!™, TRENCHSTOP™, TriCore™.

Other Trademarks

Advance Design System™ (ADS) of Agilent Technologies, AMBA™, ARM™, MULTI-ICE™, KEIL™, PRIMECELL™, REALVIEW™, THUMB™, µVision™ of ARM Limited, UK. AUTOSAR™ is licensed by AUTOSAR development partnership. Bluetooth™ of Bluetooth SIG Inc. CAT-ig™ of DECT Forum. COLOSSUS™, FirstGPS™ of Trimble Navigation Ltd. EMV™ of EMVCo, LLC (Visa Holdings Inc.). EPCOS™ of Epcos AG. FLEXGO™ of Microsoft Corporation. FlexRay™ is licensed by FlexRay Consortium. HYPERTERMINAL™ of Hilgraeve Incorporated. IEC™ of Commission Electrotechnique Internationale. IrDA™ of Infrared Data Association Corporation. ISO™ of INTERNATIONAL ORGANIZATION FOR STANDARDIZATION. MATLAB™ of MathWorks, Inc. MAXIM™ of Maxim Integrated Products, Inc. MICROTEC™, NUCLEUS™ of Mentor Graphics Corporation. MIPI™ of MIPI Alliance, Inc. MIPS™ of MIPS Technologies, Inc., USA. muRata™ of MURATA MANUFACTURING CO., MICROWAVE OFFICE™ (MWO) of Applied Wave Research Inc., OmniVision™ of OmniVision Technologies, Inc. Openwave™ Openwave Systems Inc. RED HAT™ Red Hat, Inc. RFMD™ RF Micro Devices, Inc. SIRIUS™ of Sirius Satellite Radio Inc. SOLARIS™ of Sun Microsystems, Inc. SPANSION™ of Spansion LLC Ltd. Symbian™ of Symbian Software Limited. TAIYO YUDEN™ of Taiyo Yuden Co. TEAKLITE™ of CEVA, Inc. TEKTRONIX™ of Tektronix Inc. TOKO™ of TOKO KABUSHIKI KAISHA TA. UNIX™ of X/Open Company Limited. VERILOG™, PALLADIUM™ of Cadence Design Systems, Inc. VLYNQ™ of Texas Instruments Incorporated. VXWORKS™, WIND RIVER™ of WIND RIVER SYSTEMS, INC. ZETEX™ of Diodes Zetex Limited.

Last Trademarks Update 2011-11-11

Table of Contents

	Table of Contents	4
	List of Figures	5
	List of Tables	6
1	Product Brief	7
2	Features	8
3	Maximum Ratings	9
4	Thermal Characteristics	10
5	Electrical Characteristics	11
5.1	DC Characteristics	11
5.2	General AC Characteristics	11
5.3	Frequency Dependent AC Characteristics	12
5.4	Characteristic DC Diagrams	16
5.5	Characteristic AC Diagrams	19
6	Simulation Data	26
7	Package Information TSFP-4-1	27

List of Figures

Figure 4-1	Total Power Dissipation $P_{\text{tot}} = f(T_S)$	10
Figure 5-1	BFP640F Testing Circuit.	12
Figure 5-2	Collector Current vs. Collector Emitter Voltage $I_C = f(V_{\text{CE}})$, $I_B = \text{Parameter in } \mu\text{A}$	16
Figure 5-3	DC Current Gain $h_{\text{FE}} = f(I_C)$, $V_{\text{CE}} = 3 \text{ V}$	16
Figure 5-4	Collector Current vs. Base Emitter Forward Voltage $I_C = f(V_{\text{BE}})$, $V_{\text{CE}} = 2 \text{ V}$	17
Figure 5-5	Base Current vs. Base Emitter Forward Voltage $I_B = f(V_{\text{BE}})$, $V_{\text{CE}} = 2 \text{ V}$	17
Figure 5-6	Base Current vs. Base Emitter Reverse Voltage $I_B = f(V_{\text{EB}})$, $V_{\text{CE}} = 2 \text{ V}$	18
Figure 5-7	Transition Frequency $f_T = f(I_C)$, $f = 1 \text{ GHz}$, $V_{\text{CE}} = \text{Parameter in V}$	19
Figure 5-8	3rd Order Intercept Point at output $OIP3 = f(I_C)$, $Z_S = Z_L = 50 \Omega$, Parameters: V_{CE} in V, f in MHz	19
Figure 5-9	3rd Order Intercept Point at output $OIP3$ [dBm] = $f(I_C, V_{\text{CE}})$, $Z_S = Z_L = 50 \Omega$, $f = 2.4 \text{ GHz}$	20
Figure 5-10	Compression Point at output $OP_{1\text{dB}}$ [dBm] = $f(I_C, V_{\text{CE}})$, $Z_S = Z_L = 50 \Omega$, $f = 2.4 \text{ GHz}$	20
Figure 5-11	Collector Base Capacitance $C_{\text{CB}} = f(V_{\text{CB}})$, $f = 1 \text{ MHz}$	21
Figure 5-12	Gain $G_{\text{ma}}, G_{\text{ms}}, S_{21} ^2 = f(f)$, $V_{\text{CE}} = 3 \text{ V}$, $I_C = 25 \text{ mA}$	21
Figure 5-13	Maximum Power Gain $G_{\text{max}} = f(I_C)$, $V_{\text{CE}} = 3 \text{ V}$, $f = \text{Parameter in GHz}$	22
Figure 5-14	Maximum Power Gain $G_{\text{max}} = f(V_{\text{CE}})$, $I_C = 25 \text{ mA}$, $f = \text{Parameter in GHz}$	22
Figure 5-15	Input Matching $S_{11} = f(f)$, $V_{\text{CE}} = 3 \text{ V}$, $I_C = 6 / 25 \text{ mA}$	23
Figure 5-16	Source Impedance for Minimum Noise Figure $Z_{\text{opt}} = f(f)$, $V_{\text{CE}} = 3 \text{ V}$, $I_C = 6 / 25 \text{ mA}$	23
Figure 5-17	Output Matching $S_{22} = f(f)$, $V_{\text{CE}} = 3 \text{ V}$, $I_C = 6 / 25 \text{ mA}$	24
Figure 5-18	Noise Figure $NF_{\text{min}} = f(f)$, $V_{\text{CE}} = 3 \text{ V}$, $I_C = 6 / 25 \text{ mA}$, $Z_S = Z_{\text{opt}}$	24
Figure 5-19	Noise Figure $NF_{\text{min}} = f(I_C)$, $V_{\text{CE}} = 3 \text{ V}$, $Z_S = Z_{\text{opt}}$, $f = \text{Parameter in GHz}$	25
Figure 5-20	Noise Figure $NF_{50} = f(I_C)$, $V_{\text{CE}} = 3 \text{ V}$, $Z_S = 50 \Omega$, $f = \text{Parameter in GHz}$	25
Figure 7-1	Package Outline	27
Figure 7-2	Package Footprint.	27
Figure 7-3	Marking Description (Marking BFP640F: R4s).	27
Figure 7-4	Tape Dimensions	27

List of Tables

Table 3-1	Maximum Ratings at $T_A = 25\text{ °C}$ (unless otherwise specified)	9
Table 4-1	Thermal Resistance	10
Table 5-1	DC Characteristics at $T_A = 25\text{ °C}$	11
Table 5-2	General AC Characteristics at $T_A = 25\text{ °C}$	11
Table 5-3	AC Characteristics, $V_{CE} = 3\text{ V}$, $f = 0.45\text{ GHz}$	13
Table 5-4	AC Characteristics, $V_{CE} = 3\text{ V}$, $f = 0.9\text{ GHz}$	13
Table 5-5	AC Characteristics, $V_{CE} = 3\text{ V}$, $f = 1.5\text{ GHz}$	13
Table 5-6	AC Characteristics, $V_{CE} = 3\text{ V}$, $f = 1.9\text{ GHz}$	14
Table 5-7	AC Characteristics, $V_{CE} = 3\text{ V}$, $f = 2.4\text{ GHz}$	14
Table 5-8	AC Characteristics, $V_{CE} = 3\text{ V}$, $f = 3.5\text{ GHz}$	14
Table 5-9	AC Characteristics, $V_{CE} = 3\text{ V}$, $f = 5.5\text{ GHz}$	15

1 Product Brief

The BFP640F is linear very low noise wideband NPN bipolar RF transistor. The device is based on Infineon's reliable high volume silicon germanium carbon (SiGe:C) heterojunction bipolar technology. The collector design supports voltages up to $V_{CE} = 4.1$ V and currents up to $I_C = 50$ mA. With its high linearity at currents as low as 10 mA (see Fig. 5-8) the device supports energy efficient designs. The typical transition frequency is approximately 40 GHz, hence the device offers high power gain at frequencies up to 8 GHz in amplifier applications. The device is housed in a thin small flat plastic package with visible leads.

2 Features

- Linear low noise amplifier based on Infineon’s reliable, high volume SiGe:C technology
- High linearity $OIP3 = 27.5 \text{ dBm @ } 5.5 \text{ GHz, } 3 \text{ V, } 25 \text{ mA}$
- High transition frequency $f_T = 42 \text{ GHz @ } 3 \text{ V, } 30 \text{ mA}$
- $NF_{\min} = 0.75 \text{ dB @ } 3.5 \text{ GHz, } 3 \text{ V, } 6 \text{ mA}$
- Maximum power gain $G_{ma} = 16.5 \text{ dB @ } 3.5 \text{ GHz, } 3 \text{ V, } 25 \text{ mA}$
- Low power consumption, ideal for mobile applications
- Very common as GPS low noise amplifier, see respective application notes on Infineon internet page
- Easy to use Pb-free (RoHS compliant) and halogen-free standard package with visible leads
- Qualification report according to AEC-Q101 available

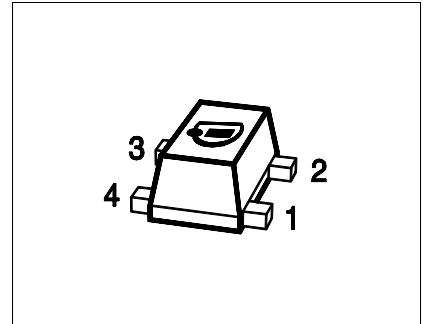

Applications

As Low Noise Amplifier (LNA) in

- Satellite communication systems: Navigation systems (GPS, Glonass), satellite radio (SDARs, DAB) and C-band LNB
- Mobile, portable and fixed connectivity applications: WLAN 802.11a/b/g/n/ac, WiMAX 2.5/3.5/5.5 GHz, UWB, Bluetooth
- Multimedia applications such as mobile/portable TV, CATV, FM Radio
- 3G/4G UMTS/LTE mobile phone applications
- ISM applications like RKE, AMR and Zigbee, as well as for emerging wireless applications

As discrete active mixer, amplifier in VCOs and buffer amplifier

Attention: ESD (Electrostatic discharge) sensitive device, observe handling precautions

Product Name	Package	Pin Configuration				Marking
BFP640F	TSFP-4-1	1 = B	2 = E	3 = C	4 = E	R4s

3 Maximum Ratings

Table 3-1 Maximum Ratings at $T_A = 25\text{ °C}$ (unless otherwise specified)

Parameter	Symbol	Values		Unit	Note / Test Condition
		Min.	Max.		
Collector emitter voltage	V_{CEO}	– –	4.1 3.6	V	Open base $T_A = 25\text{ °C}$ $T_A = -55\text{ °C}$
Collector emitter voltage	V_{CES}	–	13	V	E-B short circuited
Collector base voltage	V_{CBO}	–	13	V	Open emitter
Emitter base voltage	V_{EBO}	–	1.2	V	Open collector
Collector current	I_C	–	50	mA	–
Base current	I_B	–	3	mA	–
Total power dissipation ¹⁾	P_{tot}	–	200	mW	$T_S \leq 92\text{ °C}$
Junction temperature	T_J	–	150	°C	–
Storage temperature	T_{Stg}	-55	150	°C	–

1) T_S is the soldering point temperature. T_S is measured on the emitter lead at the soldering point of the pcb.

Attention: Stresses above the max. values listed here may cause permanent damage to the device. Exposure to absolute maximum rating conditions for extended periods may affect device reliability. Maximum ratings are absolute ratings; exceeding only one of these values may cause irreversible damage to the integrated circuit.

4 Thermal Characteristics

Table 4-1 Thermal Resistance

Parameter	Symbol	Values			Unit	Note / Test Condition
		Min.	Typ.	Max.		
Junction - soldering point ¹⁾	R_{thJS}	–	–	290	K/W	–

1) For the definition of R_{thJS} please refer to Application Note AN077 (Thermal Resistance Calculation)

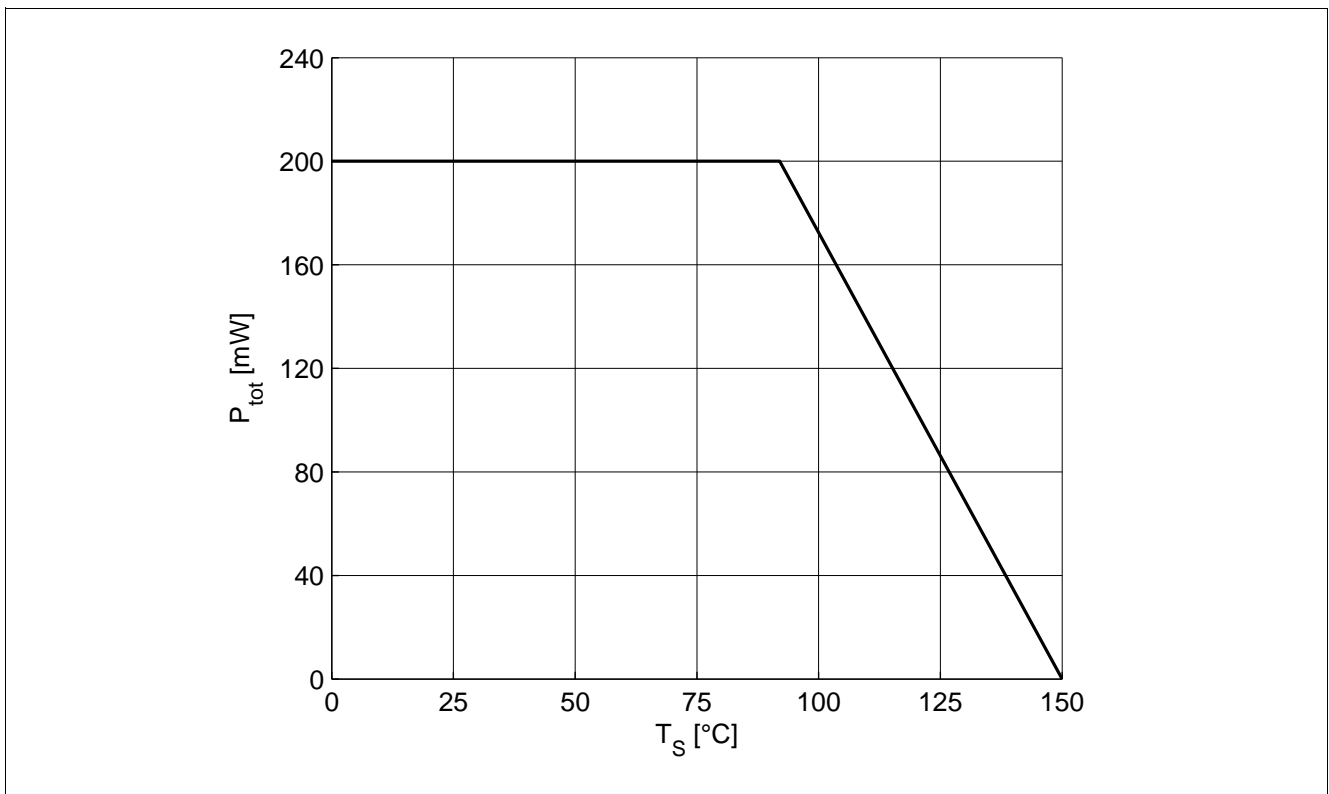

Figure 4-1 Total Power Dissipation $P_{tot} = f(T_s)$

5 Electrical Characteristics

5.1 DC Characteristics

Table 5-1 DC Characteristics at $T_A = 25\text{ °C}$

Parameter	Symbol	Values			Unit	Note / Test Condition
		Min.	Typ.	Max.		
Collector emitter breakdown voltage	$V_{(BR)CEO}$	4.1	4.7	–	V	$I_C = 1\text{ mA}$, $I_B = 0$ Open base
Collector emitter leakage current	I_{CES}	–	1 1	400 ¹⁾ 40 ¹⁾	nA	$V_{CE} = 13\text{ V}$, $V_{BE} = 0$ $V_{CE} = 5\text{ V}$, $V_{BE} = 0$ E-B short circuited
Collector base leakage current	I_{CBO}	–	1	40 ¹⁾	nA	$V_{CB} = 5\text{ V}$, $I_E = 0$ Open emitter
Emitter base leakage current	I_{EBO}	–	1	40 ¹⁾	nA	$V_{EB} = 0.5\text{ V}$, $I_C = 0$ Open collector
DC current gain	h_{FE}	110	180	270		$V_{CE} = 3\text{ V}$, $I_C = 30\text{ mA}$ Pulse measured

1) Maximum values not limited by the device but by the short cycle time of the 100% test

5.2 General AC Characteristics

Table 5-2 General AC Characteristics at $T_A = 25\text{ °C}$

Parameter	Symbol	Values			Unit	Note / Test Condition
		Min.	Typ.	Max.		
Transition frequency	f_T	–	42	–	GHz	$V_{CE} = 3\text{ V}$, $I_C = 30\text{ mA}$ $f = 1\text{ GHz}$
Collector base capacitance	C_{CB}	–	0.09	–	pF	$V_{CB} = 3\text{ V}$, $V_{BE} = 0$ $f = 1\text{ MHz}$ Emitter grounded
Collector emitter capacitance	C_{CE}	–	0.2	–	pF	$V_{CE} = 3\text{ V}$, $V_{BE} = 0$ $f = 1\text{ MHz}$ Base grounded
Emitter base capacitance	C_{EB}	–	0.47	–	pF	$V_{EB} = 0.5\text{ V}$, $V_{CB} = 0$ $f = 1\text{ MHz}$ Collector grounded

5.3 Frequency Dependent AC Characteristics

Measurement setup is a test fixture with Bias T's in a 50 Ω system, $T_A = 25\text{ }^\circ\text{C}$

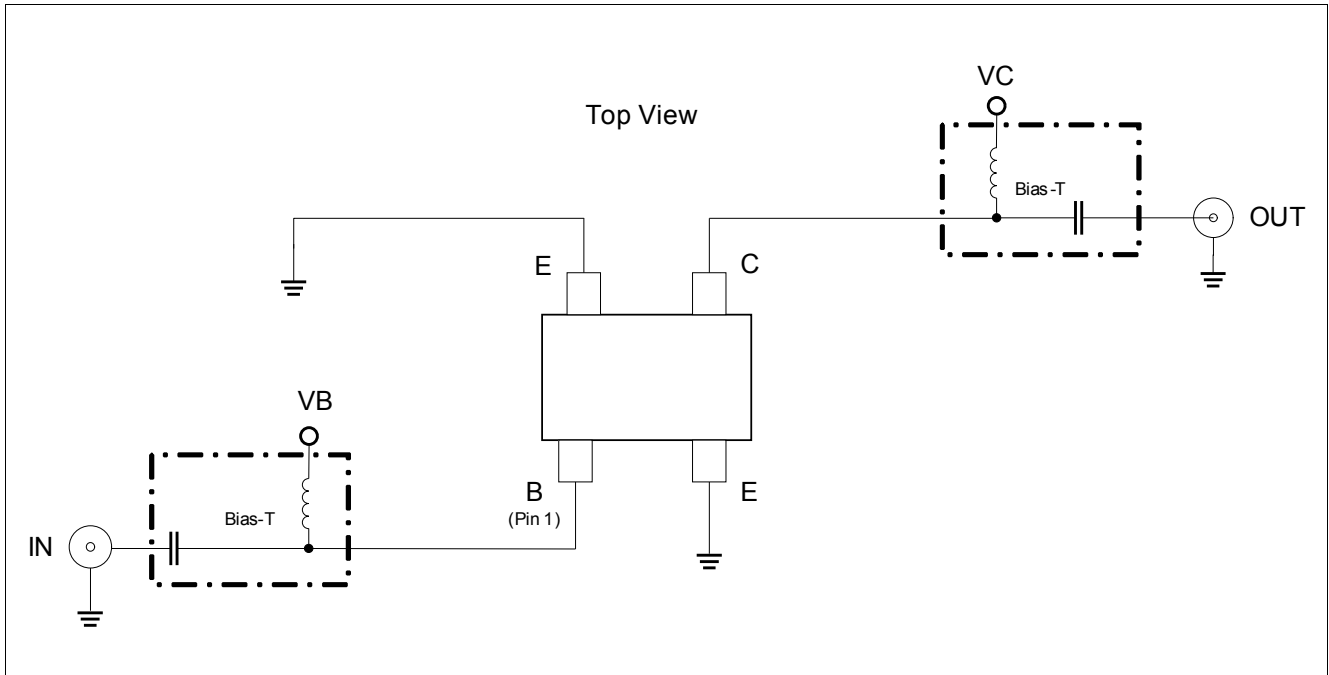

Figure 5-1 BFP640F Testing Circuit

Electrical Characteristics
Table 5-3 AC Characteristics, $V_{CE} = 3\text{ V}$, $f = 0.45\text{ GHz}$

Parameter	Symbol	Values			Unit	Note / Test Condition
		Min.	Typ.	Max.		
Power Gain						
Maximum power gain	G_{ms}	–	33	–	dB	$I_C = 25\text{ mA}$
Transducer gain	$ S_{21} ^2$	–	31	–		
Minimum Noise Figure						
Minimum noise figure	NF_{min}	–	0.55	–	dB	$I_C = 6\text{ mA}$
Associated gain	G_{ass}	–	26	–		
Linearity						
1 dB compression point at output	OP_{1dB}	–	10.5	–	dBm	$Z_S = Z_L = 50\ \Omega$ $I_C = 25\text{ mA}$
3rd order intercept point at output	$OIP3$	–	23.5	–		

Table 5-4 AC Characteristics, $V_{CE} = 3\text{ V}$, $f = 0.9\text{ GHz}$

Parameter	Symbol	Values			Unit	Note / Test Condition
		Min.	Typ.	Max.		
Power Gain						
Maximum power gain	G_{ms}	–	28.5	–	dB	$I_C = 25\text{ mA}$
Transducer gain	$ S_{21} ^2$	–	26.5	–		
Minimum Noise Figure						
Minimum noise figure	NF_{min}	–	0.55	–	dB	$I_C = 6\text{ mA}$
Associated gain	G_{ass}	–	23.5	–		
Linearity						
1 dB compression point at output	OP_{1dB}	–	12.5	–	dBm	$Z_S = Z_L = 50\ \Omega$ $I_C = 25\text{ mA}$
3rd order intercept point at output	$OIP3$	–	26	–		

Table 5-5 AC Characteristics, $V_{CE} = 3\text{ V}$, $f = 1.5\text{ GHz}$

Parameter	Symbol	Values			Unit	Note / Test Condition
		Min.	Typ.	Max.		
Power Gain						
Maximum power gain	G_{ms}	–	25	–	dB	$I_C = 25\text{ mA}$
Transducer gain	$ S_{21} ^2$	–	22.5	–		
Minimum Noise Figure						
Minimum noise figure	NF_{min}	–	0.6	–	dB	$I_C = 6\text{ mA}$
Associated gain	G_{ass}	–	20.5	–		
Linearity						
1 dB compression point at output	OP_{1dB}	–	12	–	dBm	$Z_S = Z_L = 50\ \Omega$ $I_C = 25\text{ mA}$
3rd order intercept point at output	$OIP3$	–	26	–		

Electrical Characteristics
Table 5-6 AC Characteristics, $V_{CE} = 3\text{ V}$, $f = 1.9\text{ GHz}$

Parameter	Symbol	Values			Unit	Note / Test Condition
		Min.	Typ.	Max.		
Power Gain						
Maximum power gain	G_{ms}	–	23	–	dB	$I_C = 25\text{ mA}$
Transducer gain	$ S_{21} ^2$	–	20.5	–		$I_C = 25\text{ mA}$
Minimum Noise Figure						
Minimum noise figure	NF_{min}	–	0.6	–	dB	$I_C = 6\text{ mA}$
Associated gain	G_{ass}	–	19	–		$I_C = 6\text{ mA}$
Linearity						
1 dB compression point at output	OP_{1dB}	–	12.5	–	dBm	$Z_S = Z_L = 50\ \Omega$ $I_C = 25\text{ mA}$
3rd order intercept point at output	$OIP3$	–	27	–		$I_C = 25\text{ mA}$

Table 5-7 AC Characteristics, $V_{CE} = 3\text{ V}$, $f = 2.4\text{ GHz}$

Parameter	Symbol	Values			Unit	Note / Test Condition
		Min.	Typ.	Max.		
Power Gain						
Maximum power gain	G_{ma}	–	20	–	dB	$I_C = 25\text{ mA}$
Transducer gain	$ S_{21} ^2$	–	18.5	–		$I_C = 25\text{ mA}$
Minimum Noise Figure						
Minimum noise figure	NF_{min}	–	0.65	–	dB	$I_C = 6\text{ mA}$
Associated gain	G_{ass}	–	17	–		$I_C = 6\text{ mA}$
Linearity						
1 dB compression point at output	OP_{1dB}	–	12.5	–	dBm	$Z_S = Z_L = 50\ \Omega$ $I_C = 25\text{ mA}$
3rd order intercept point at output	$OIP3$	–	28	–		$I_C = 25\text{ mA}$

Table 5-8 AC Characteristics, $V_{CE} = 3\text{ V}$, $f = 3.5\text{ GHz}$

Parameter	Symbol	Values			Unit	Note / Test Condition
		Min.	Typ.	Max.		
Power Gain						
Maximum power gain	G_{ma}	–	16.5	–	dB	$I_C = 25\text{ mA}$
Transducer gain	$ S_{21} ^2$	–	15.5	–		$I_C = 25\text{ mA}$
Minimum Noise Figure						
Minimum noise figure	NF_{min}	–	0.75	–	dB	$I_C = 6\text{ mA}$
Associated gain	G_{ass}	–	14	–		$I_C = 6\text{ mA}$
Linearity						
1 dB compression point at output	OP_{1dB}	–	12	–	dBm	$Z_S = Z_L = 50\ \Omega$ $I_C = 25\text{ mA}$
3rd order intercept point at output	$OIP3$	–	27.5	–		$I_C = 25\text{ mA}$

Table 5-9 AC Characteristics, $V_{CE} = 3\text{ V}$, $f = 5.5\text{ GHz}$

Parameter	Symbol	Values			Unit	Note / Test Condition
		Min.	Typ.	Max.		
Power Gain						
Maximum power gain	G_{ma}	–	12.5	–	dB	$I_C = 25\text{ mA}$
Transducer gain	$ S_{21} ^2$	–	11.5	–		
Minimum Noise Figure						
Minimum noise figure	NF_{min}	–	1.0	–	dB	$I_C = 6\text{ mA}$
Associated gain	G_{ass}	–	11	–		
Linearity						
1 dB compression point at output	OP_{1dB}	–	12.5	–	dBm	$Z_S = Z_L = 50\ \Omega$
3rd order intercept point at output	$OIP3$	–	27.5	–		

Note: $OIP3$ value depends on termination of all intermodulation frequency components. Termination used for this measurement is $50\ \Omega$ from 0.2 MHz to 12 GHz.

5.4 Characteristic DC Diagrams

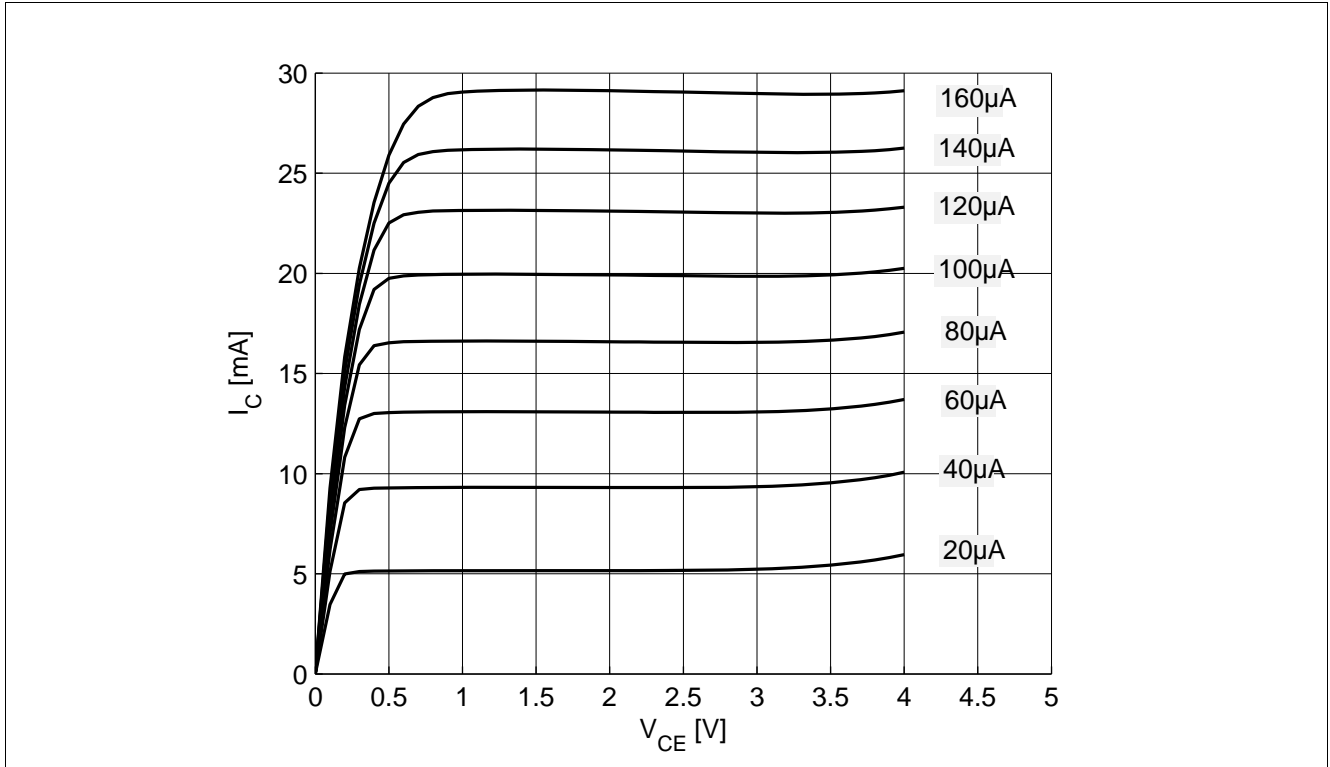

Figure 5-2 Collector Current vs. Collector Emitter Voltage $I_C = f(V_{CE})$, $I_B = \text{Parameter in } \mu\text{A}$

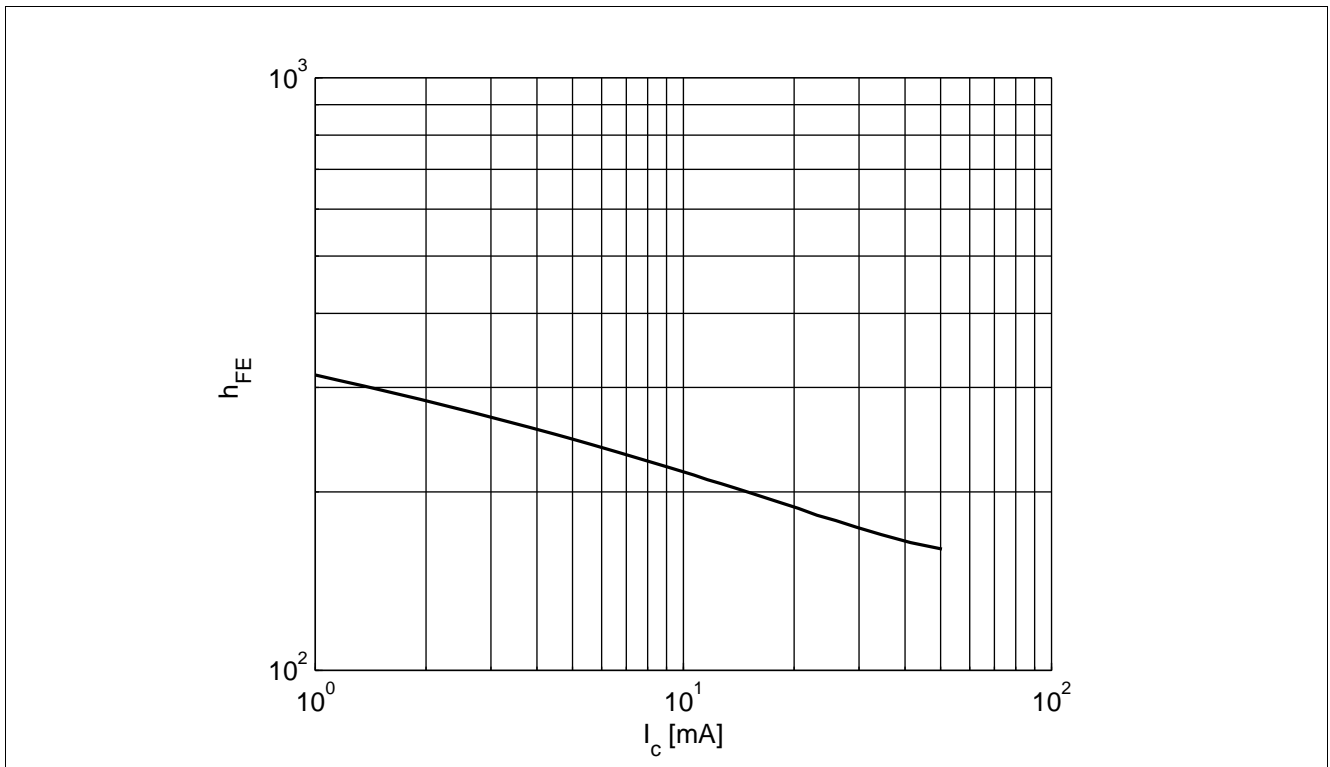

Figure 5-3 DC Current Gain $h_{FE} = f(I_C)$, $V_{CE} = 3 \text{ V}$

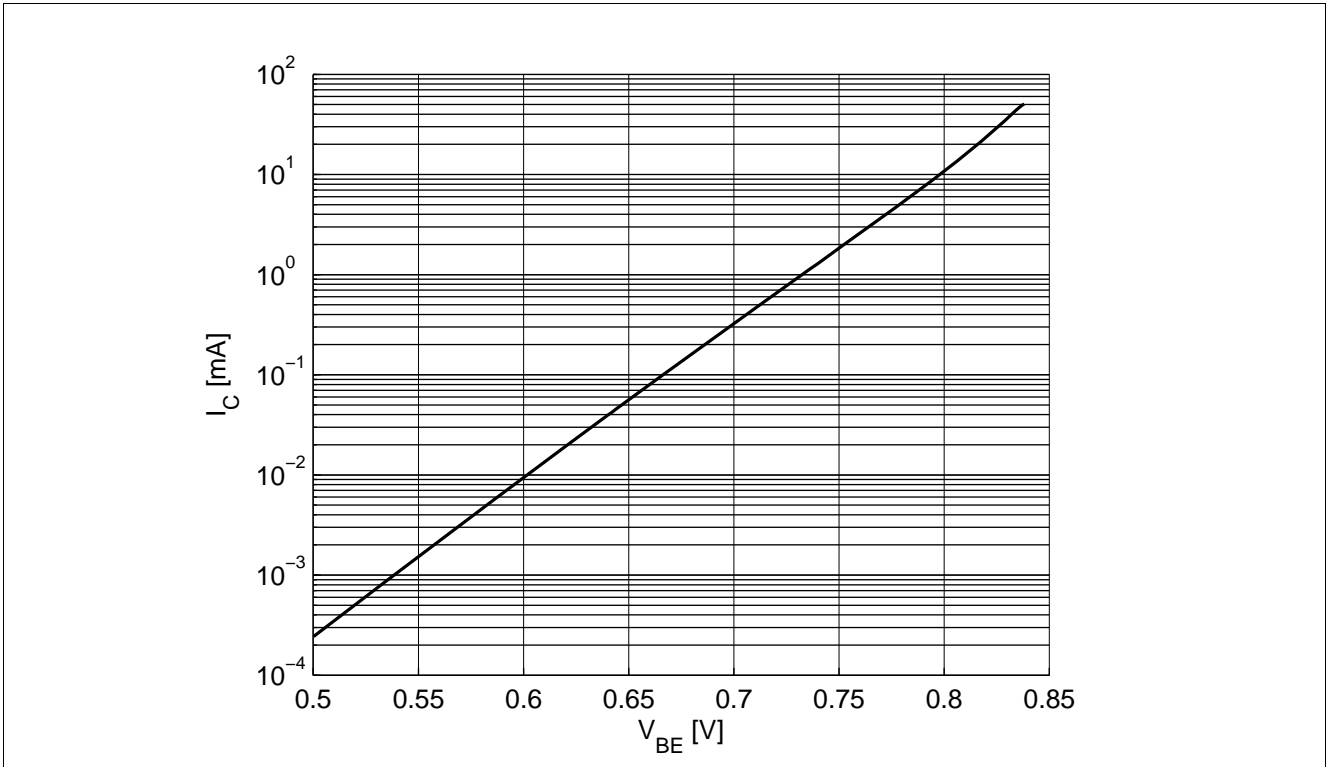

Figure 5-4 Collector Current vs. Base Emitter Forward Voltage $I_C = f(V_{BE})$, $V_{CE} = 2\text{ V}$

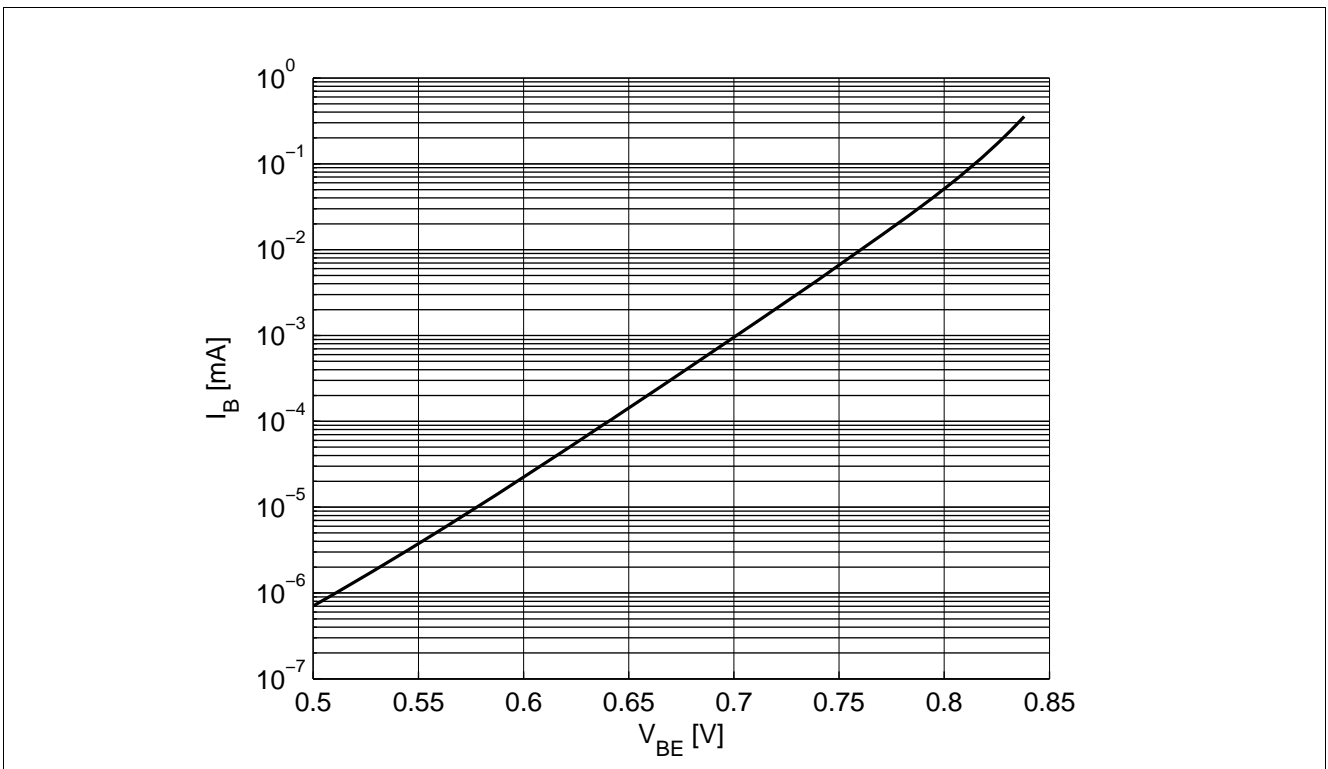

Figure 5-5 Base Current vs. Base Emitter Forward Voltage $I_B = f(V_{BE})$, $V_{CE} = 2\text{ V}$

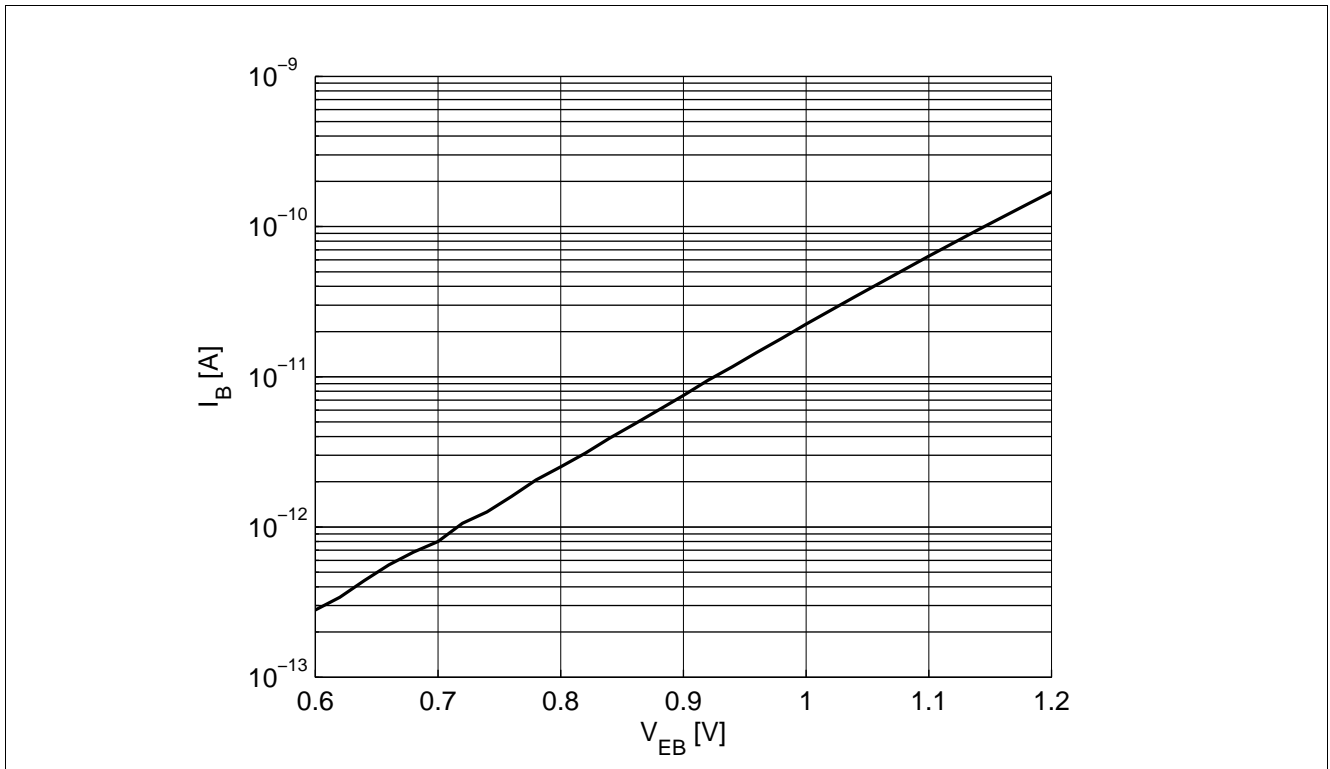

Figure 5-6 Base Current vs. Base Emitter Reverse Voltage $I_B = f(V_{EB})$, $V_{CE} = 2\text{ V}$

5.5 Characteristic AC Diagrams

Measurement setup is a test fixture with Bias T's in a 50 Ω system, $T_A = 25\text{ }^\circ\text{C}$.

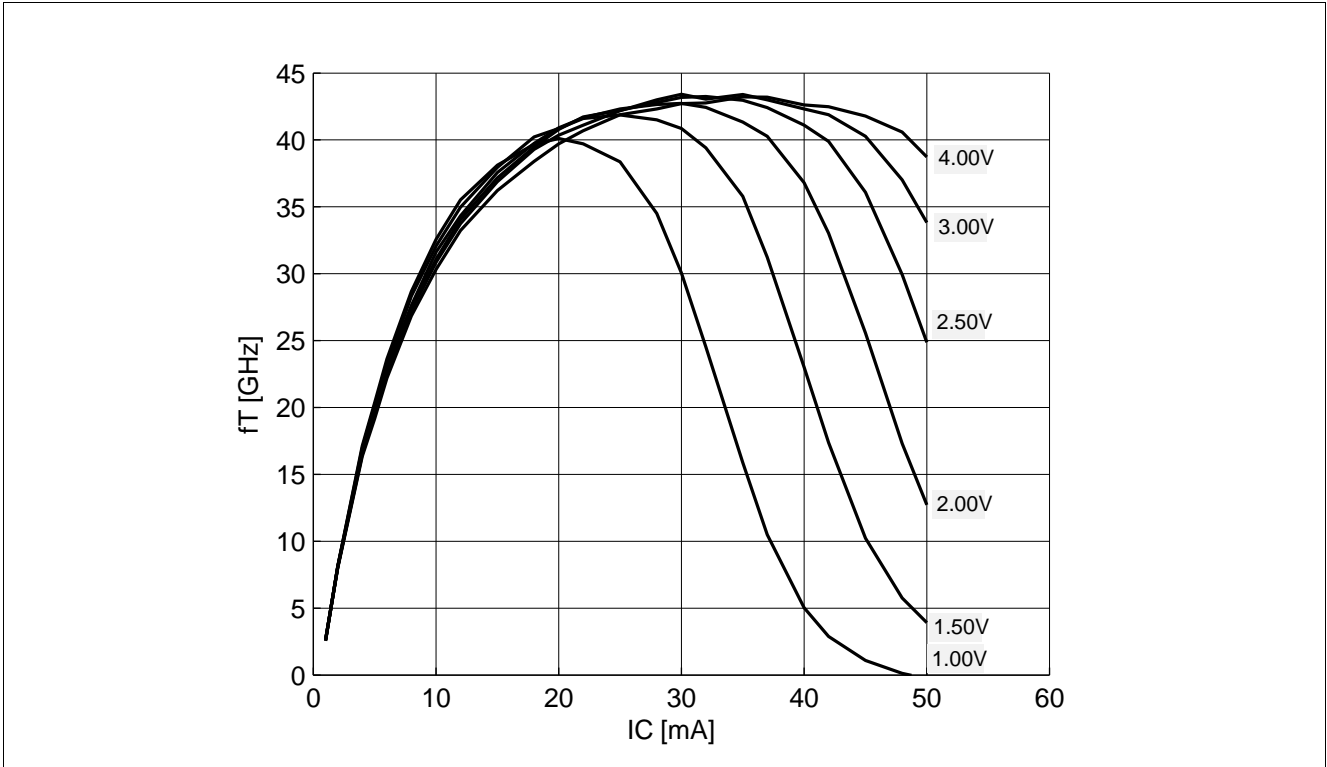

Figure 5-7 Transition Frequency $f_T = f(I_C)$, $f = 1\text{ GHz}$, $V_{CE} = \text{Parameter in V}$

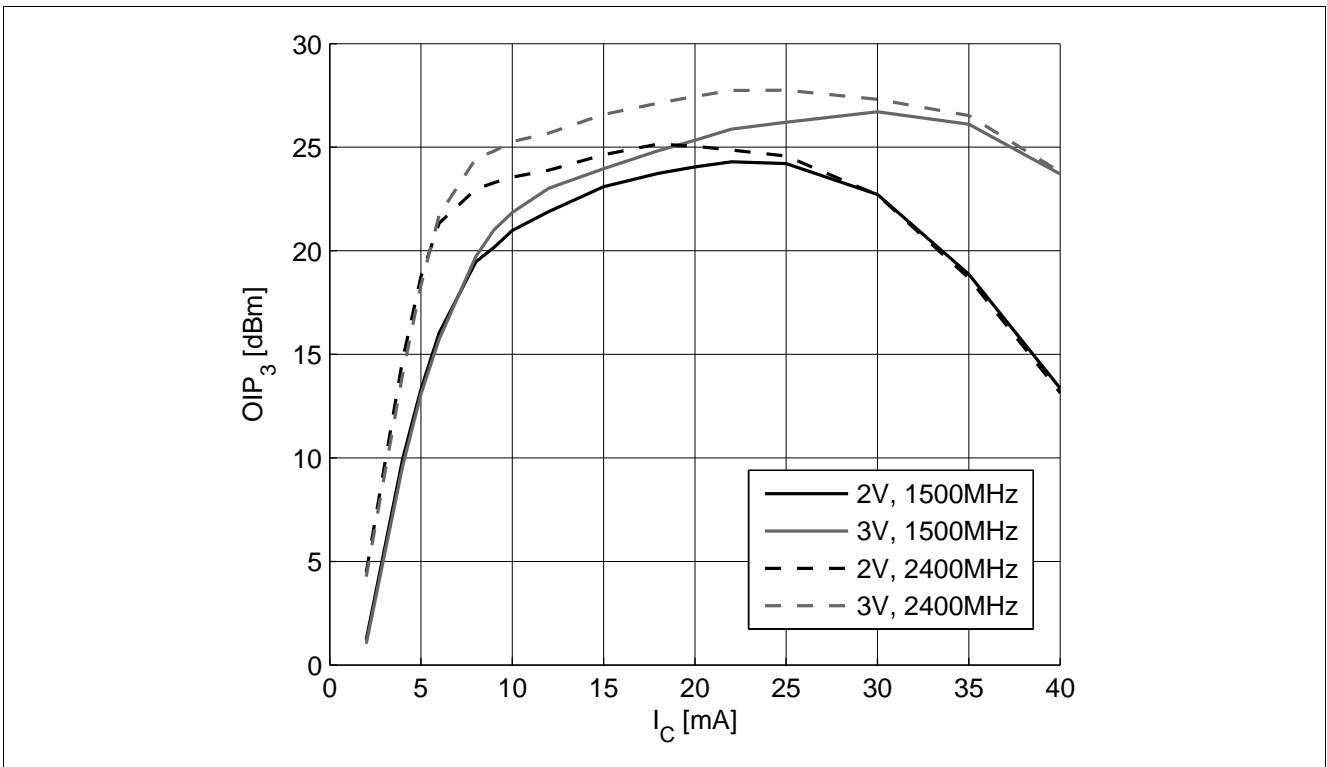

Figure 5-8 3rd Order Intercept Point at output $OIP_3 = f(I_C)$, $Z_S = Z_L = 50\text{ }\Omega$, Parameters: V_{CE} in V, f in MHz

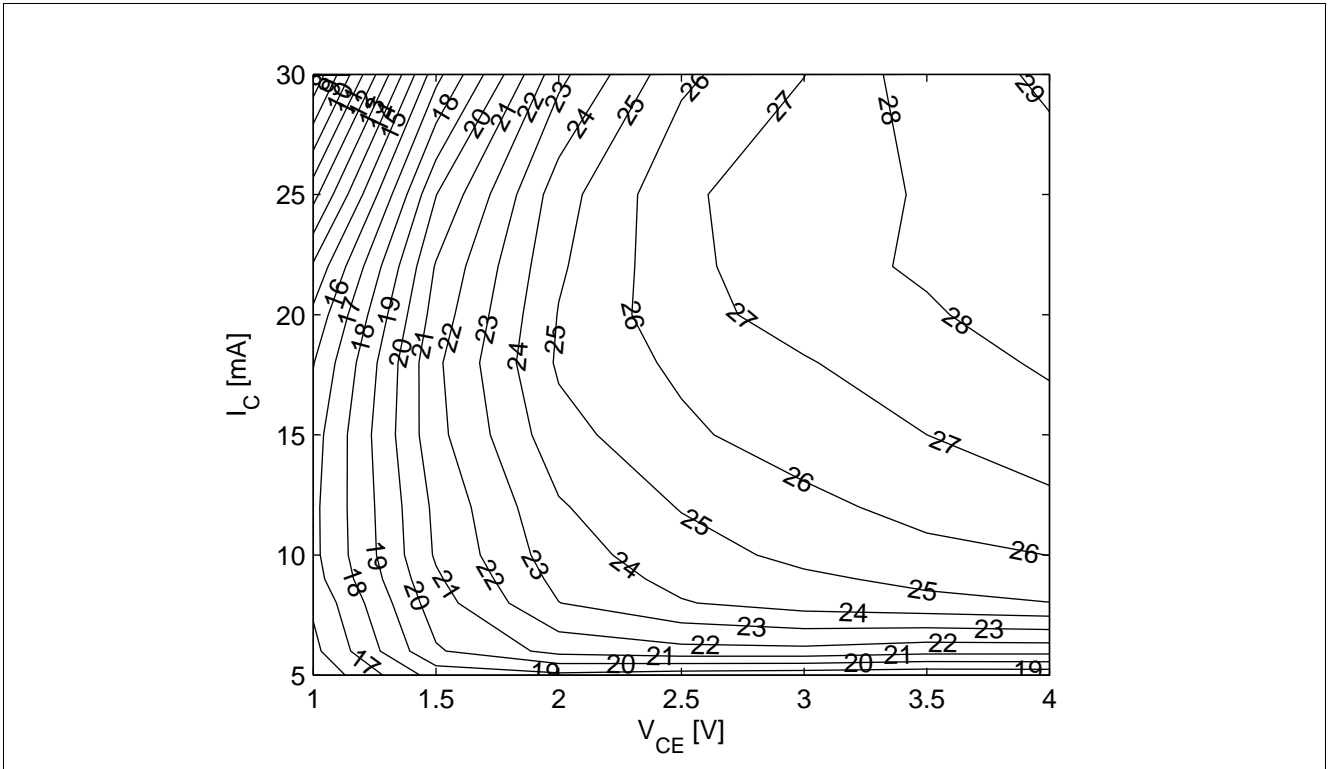

Figure 5-9 3rd Order Intercept Point at output $OIP3$ [dBm] = $f(I_C, V_{CE})$, $Z_S = Z_L = 50 \Omega$, $f = 2.4$ GHz

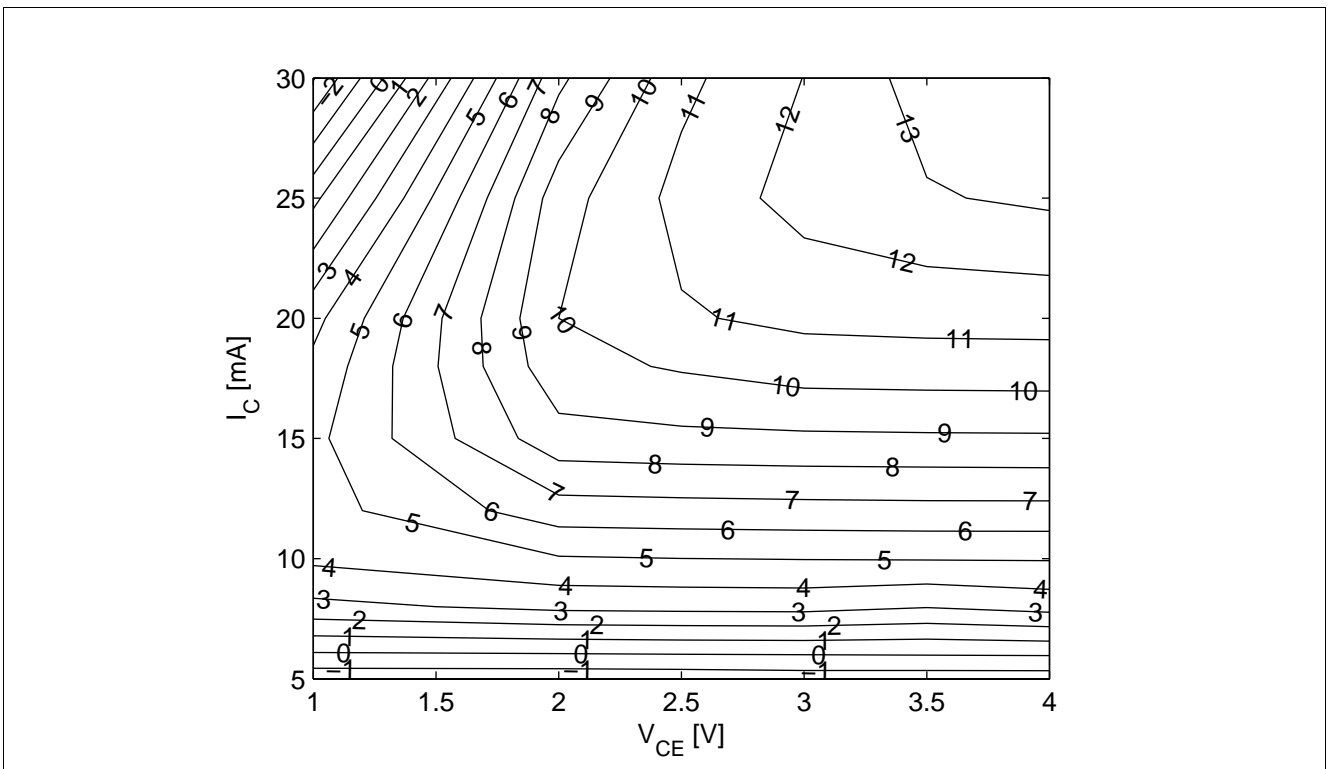

Figure 5-10 Compression Point at output OP_{1dB} [dBm] = $f(I_C, V_{CE})$, $Z_S = Z_L = 50 \Omega$, $f = 2.4$ GHz

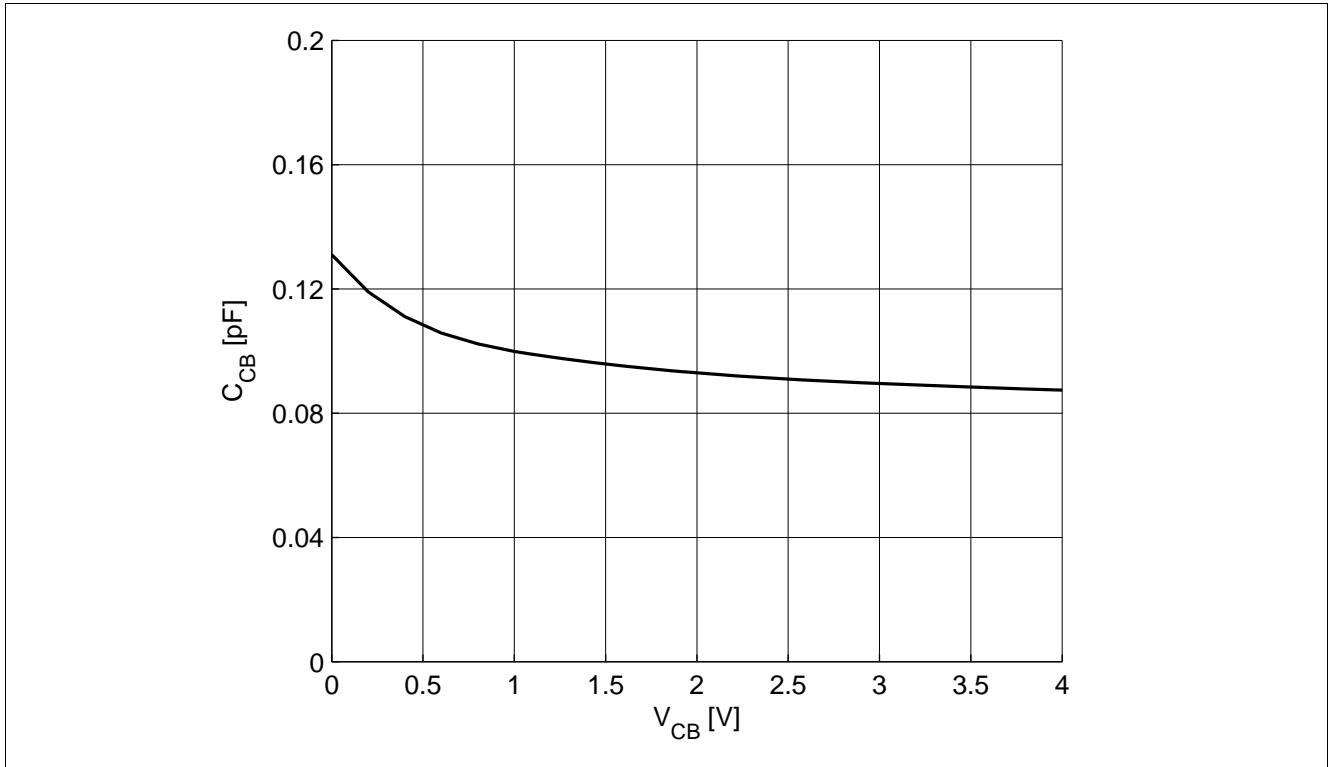

Figure 5-11 Collector Base Capacitance $C_{CB} = f(V_{CB})$, $f = 1$ MHz

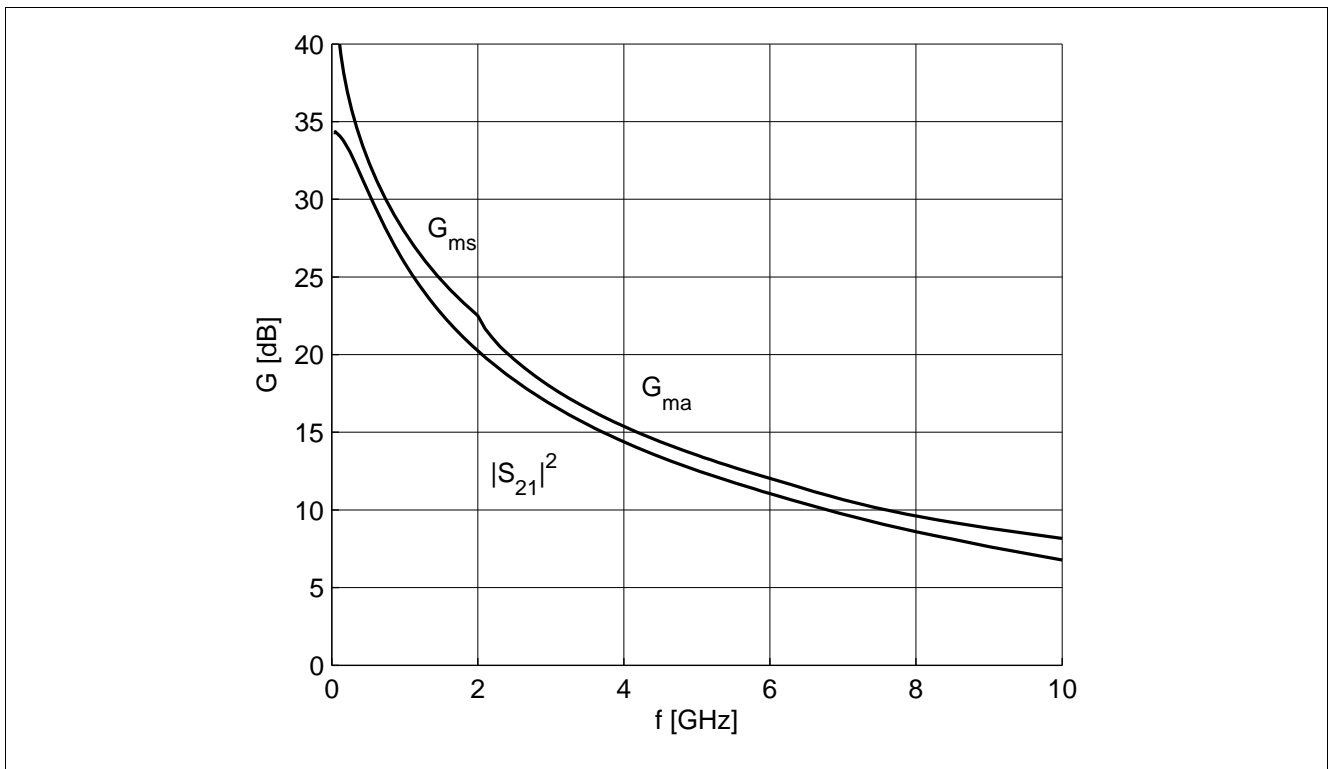

Figure 5-12 Gain G_{ma} , G_{ms} , $|S_{21}|^2 = f(f)$, $V_{CE} = 3$ V, $I_C = 25$ mA

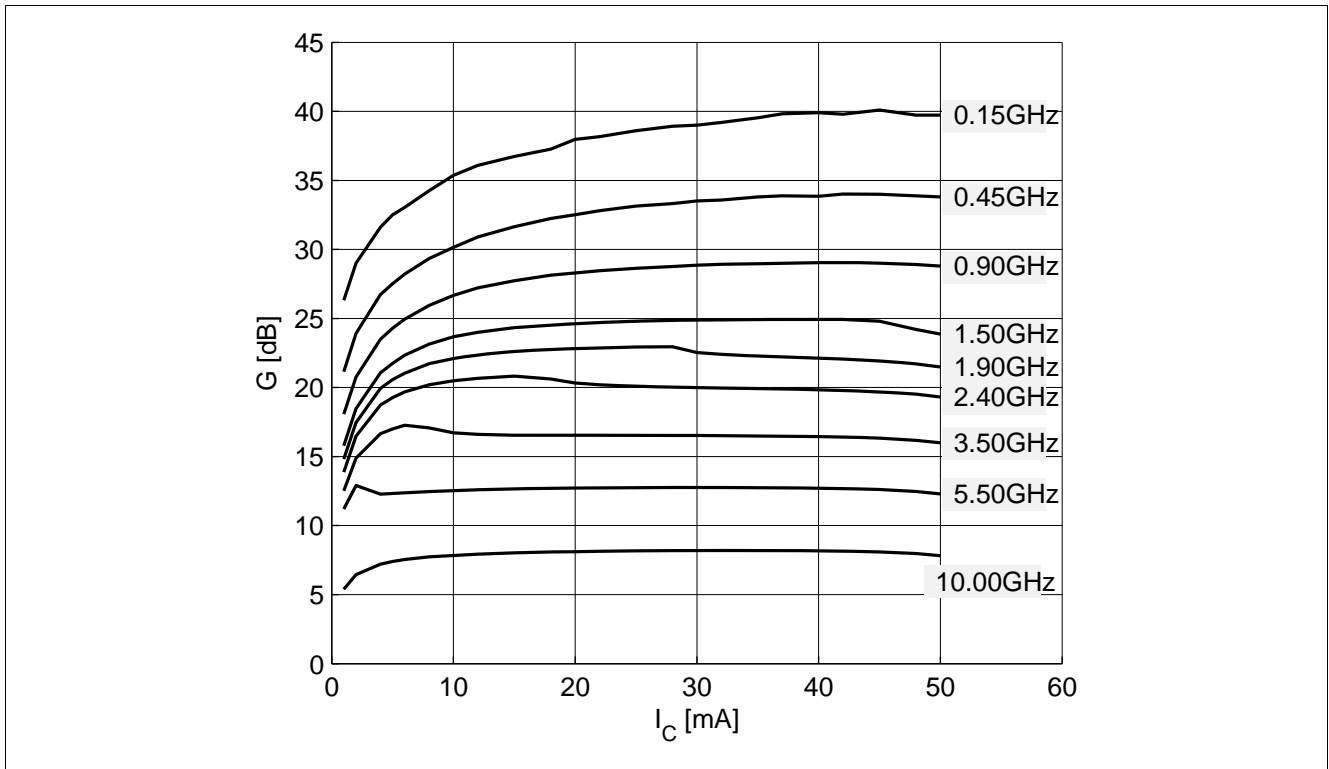

Figure 5-13 Maximum Power Gain $G_{max} = f(I_C)$, $V_{CE} = 3$ V, $f =$ Parameter in GHz

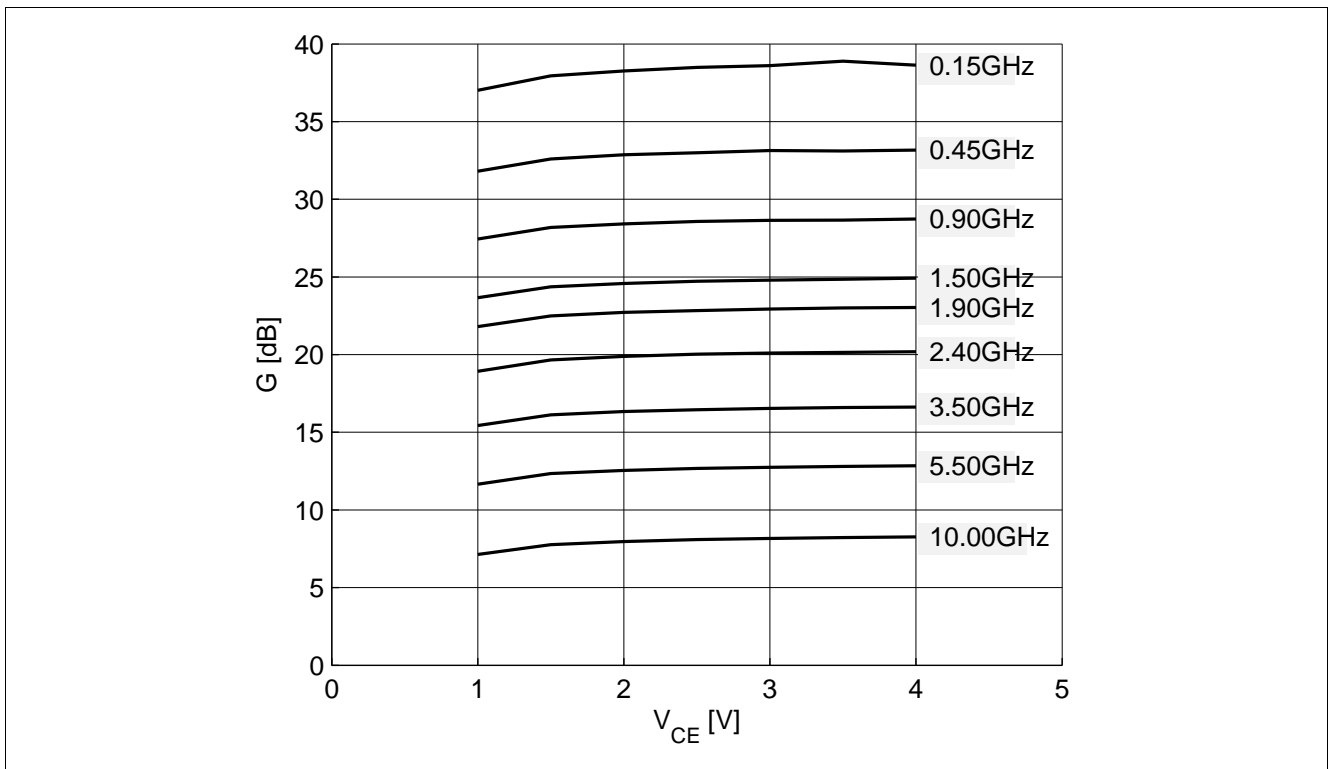

Figure 5-14 Maximum Power Gain $G_{max} = f(V_{CE})$, $I_C = 25$ mA, $f =$ Parameter in GHz

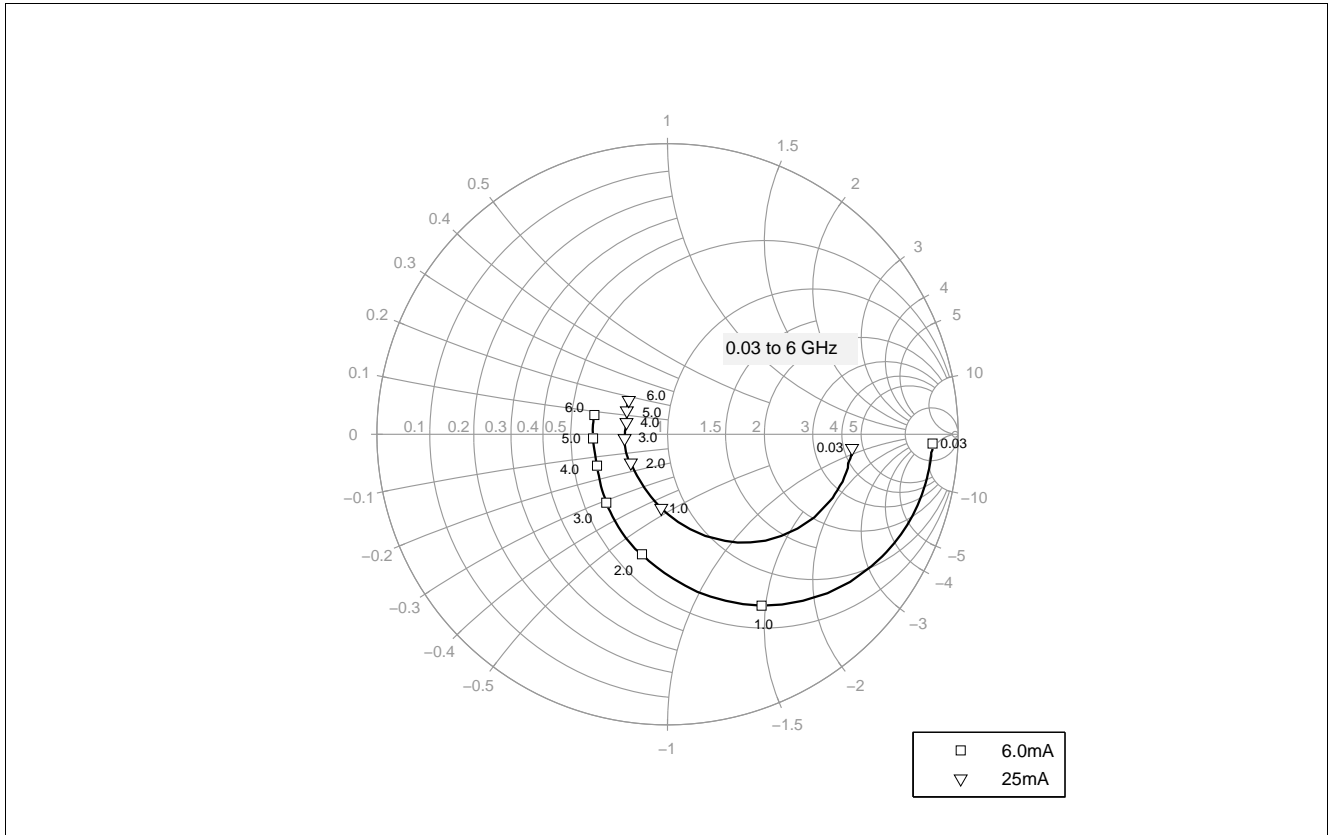

Figure 5-15 Input Matching $S_{11} = f(f)$, $V_{CE} = 3\text{ V}$, $I_C = 6 / 25\text{ mA}$

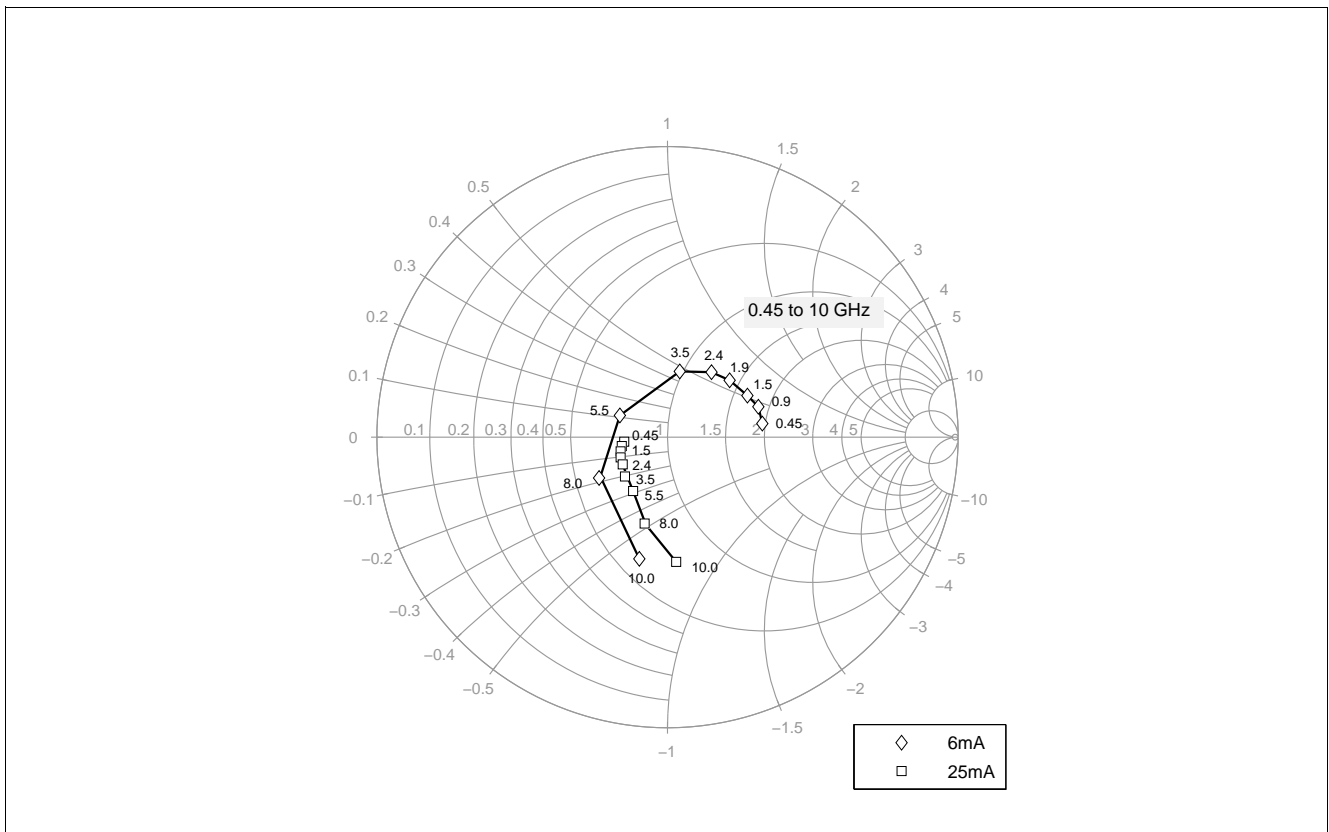

Figure 5-16 Source Impedance for Minimum Noise Figure $Z_{opt} = f(f)$, $V_{CE} = 3\text{ V}$, $I_C = 6 / 25\text{ mA}$

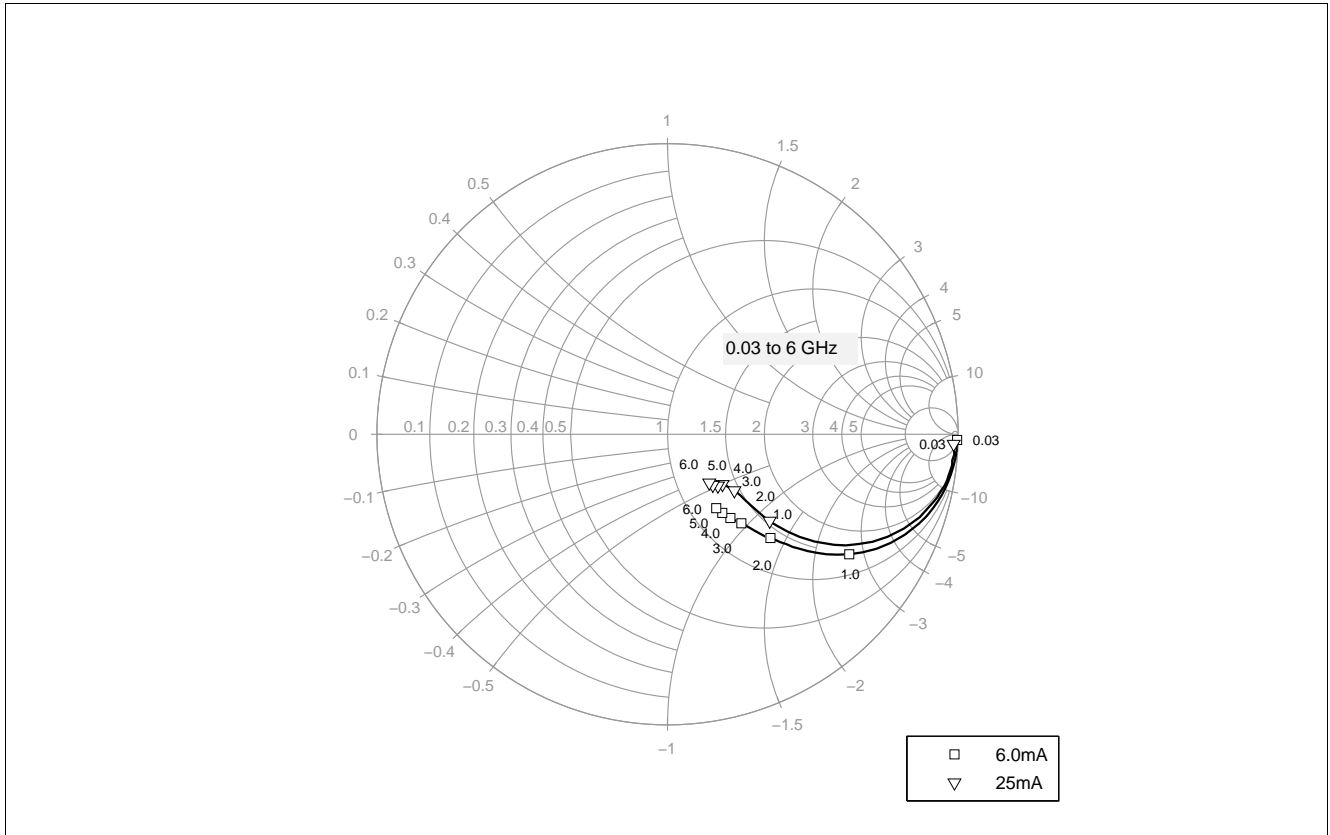

Figure 5-17 Output Matching $S_{22} = f(f)$, $V_{CE} = 3\text{ V}$, $I_C = 6 / 25\text{ mA}$

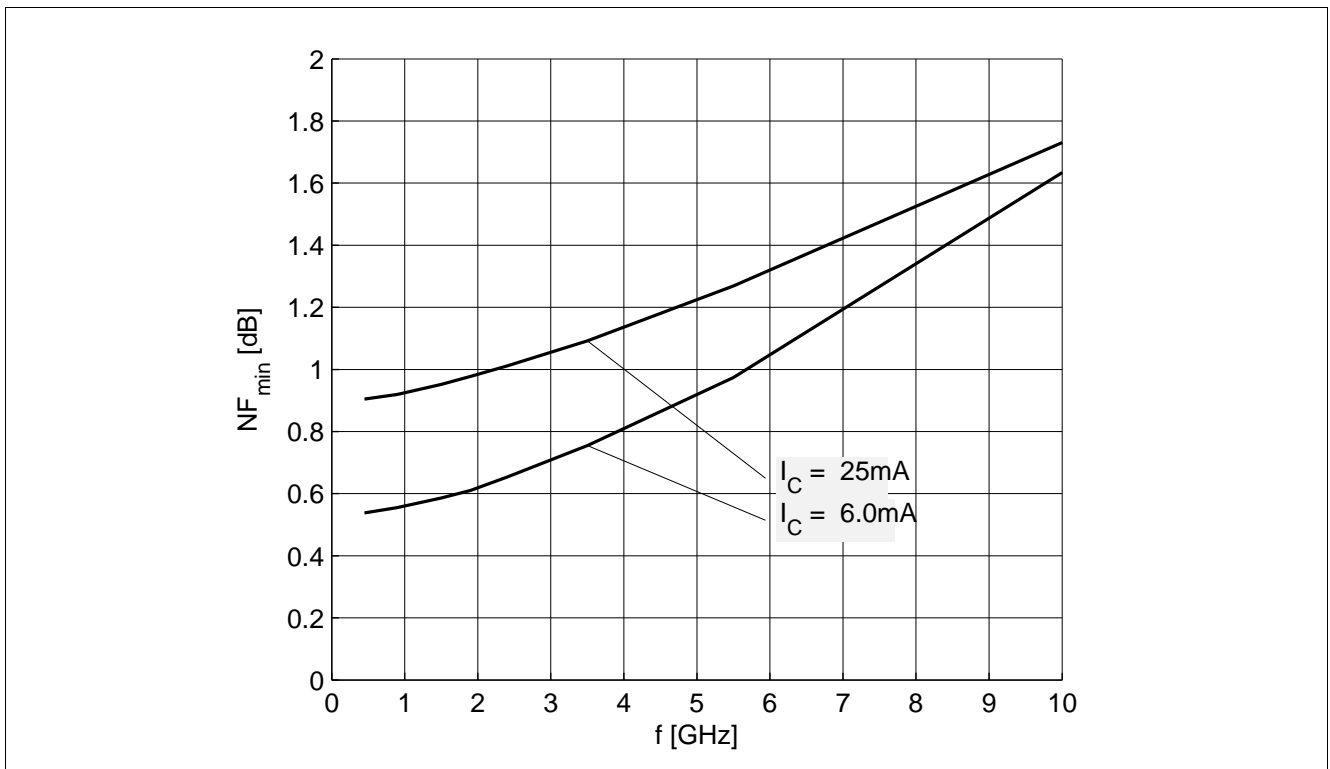

Figure 5-18 Noise Figure $NF_{min} = f(f)$, $V_{CE} = 3\text{ V}$, $I_C = 6 / 25\text{ mA}$, $Z_S = Z_{opt}$

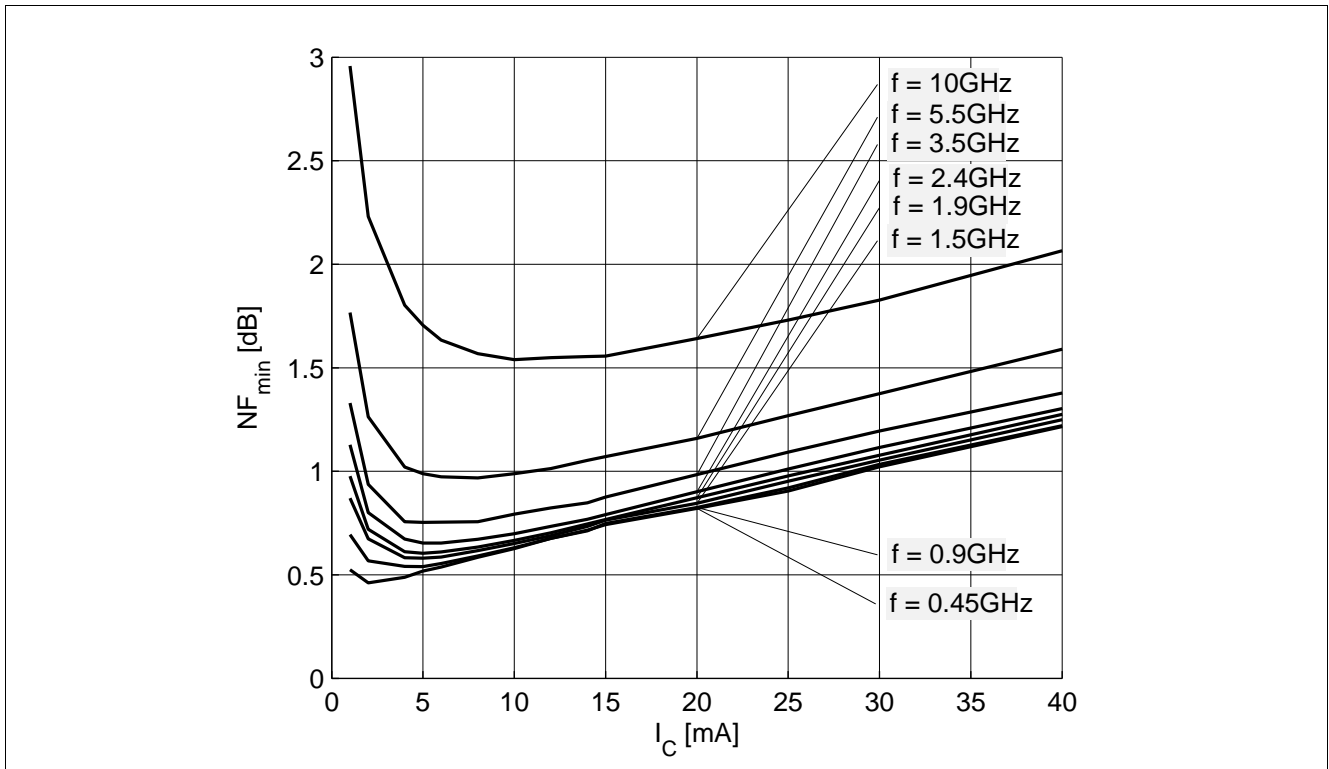

Figure 5-19 Noise Figure $NF_{min} = f(I_C)$, $V_{CE} = 3\text{ V}$, $Z_S = Z_{opt}$, $f = \text{Parameter in GHz}$

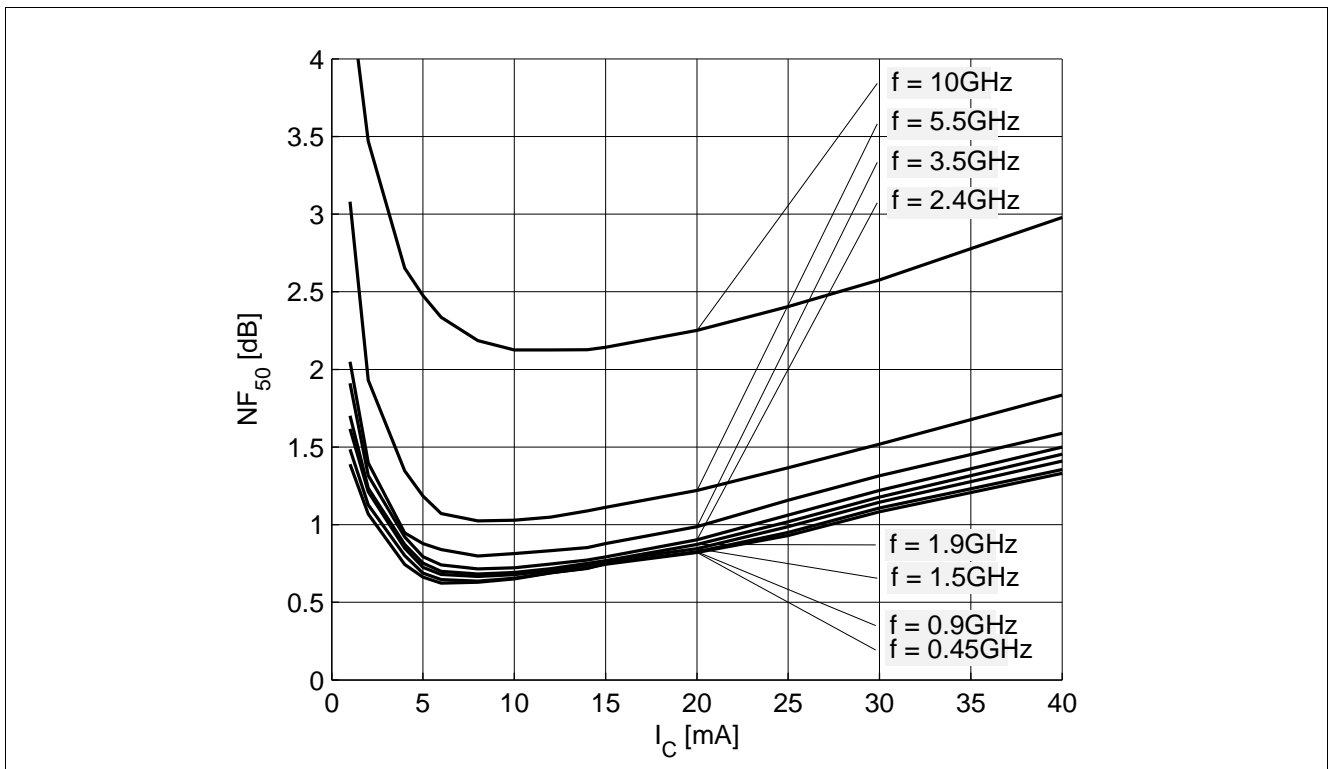

Figure 5-20 Noise Figure $NF_{50} = f(I_C)$, $V_{CE} = 3\text{ V}$, $Z_S = 50\ \Omega$, $f = \text{Parameter in GHz}$

Note: The curves shown in this chapter have been generated using typical devices but shall not be considered as a guarantee that all devices have identical characteristic curves.

6 Simulation Data

For the SPICE Gummel Poon (GP) model as well as for the S-parameters (including noise parameters) please refer to our internet website. Please consult our website and download the latest versions before actually starting your design.

You find the BFP640F SPICE GP model in the internet in MWO- and ADS-format, which you can import into these circuit simulation tools very quickly and conveniently. The model already contains the package parasitics and is ready to use for DC and high frequency simulations. The terminals of the model circuit correspond to the pin configuration of the device.

The model parameters have been extracted and verified up to 6 GHz using typical devices. The BFP640F SPICE GP model reflects the typical DC- and RF-performance within the limitations which are given by the SPICE GP model itself. Besides the DC characteristics all S-parameters in magnitude and phase, as well as noise figure (including optimum source impedance, equivalent noise resistance and flicker noise) and intermodulation have been extracted.

7 Package Information TSFP-4-1

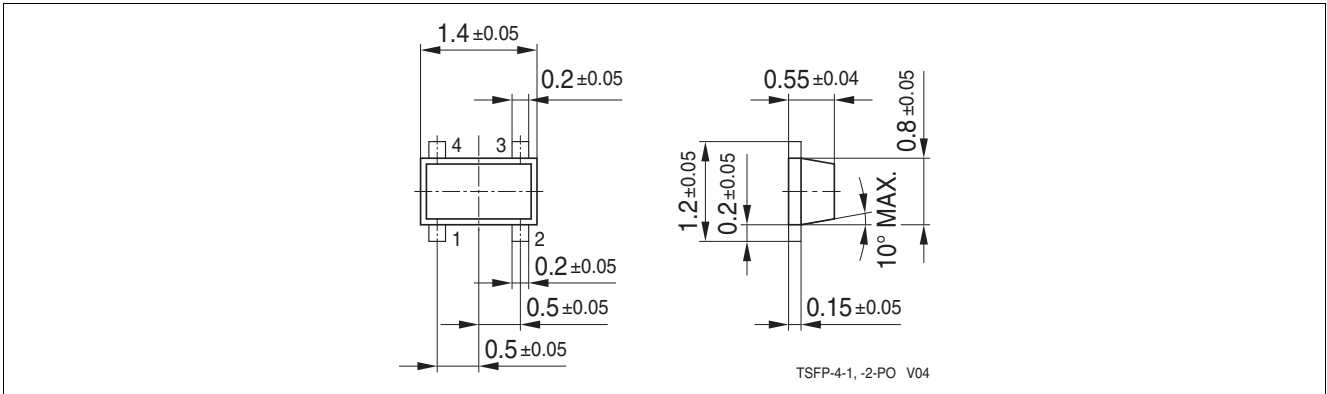

Figure 7-1 Package Outline

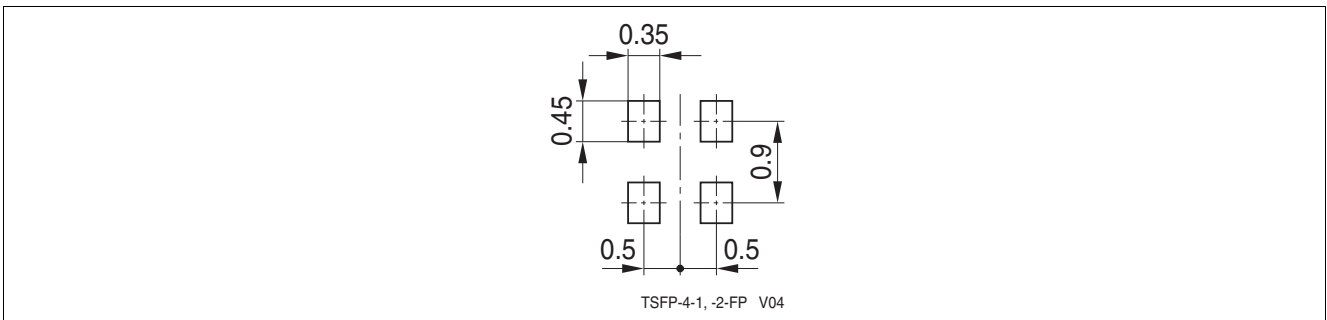

Figure 7-2 Package Footprint

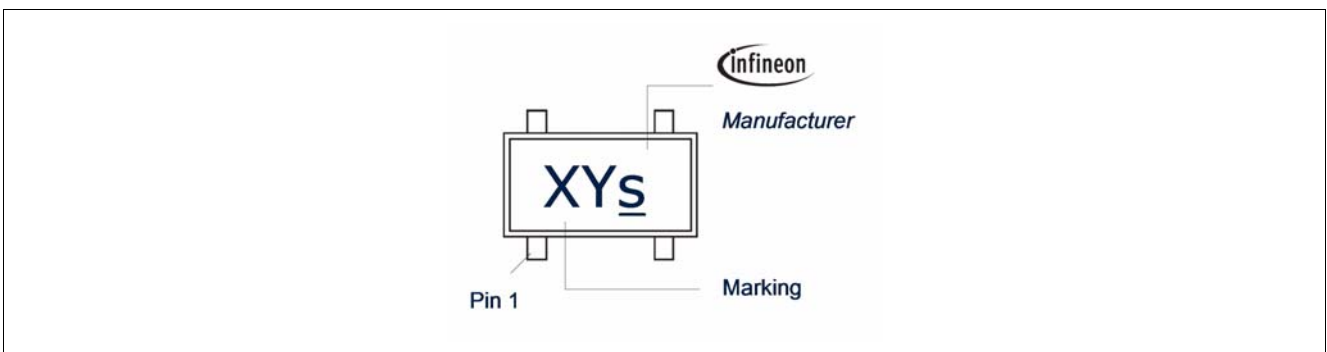

Figure 7-3 Marking Description (Marking BFP640F: R4s)

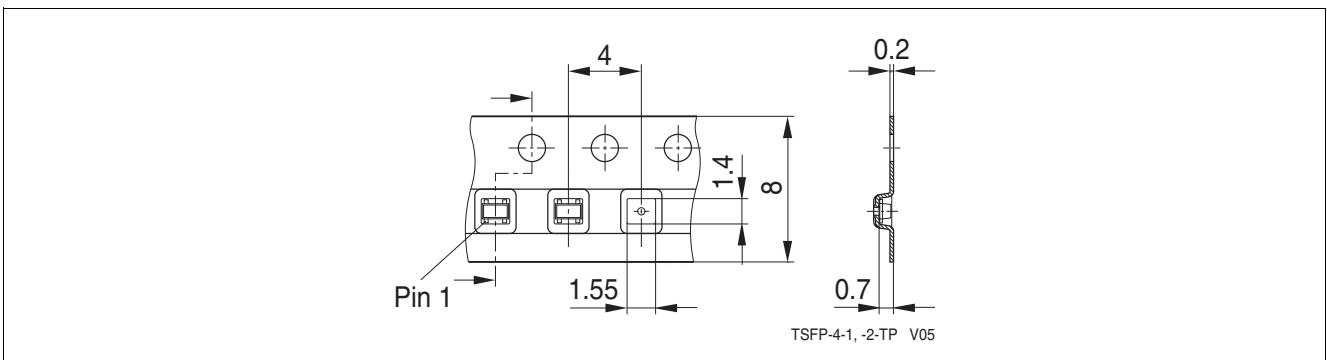

Figure 7-4 Tape Dimensions

www.infineon.com

Published by Infineon Technologies AG

Downloaded From [Oneyac.com](https://www.oneyac.com)

单击下面可查看定价，库存，交付和生命周期等信息

[>>Infineon Technologies\(英飞凌\)](#)

[>>点击查看相关商品](#)